

Mod. 220 / 546

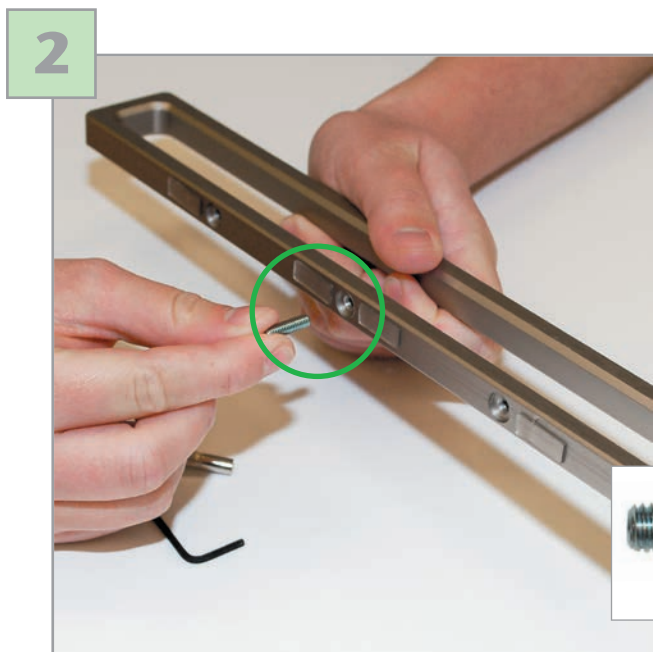

Mod. 215 / 546

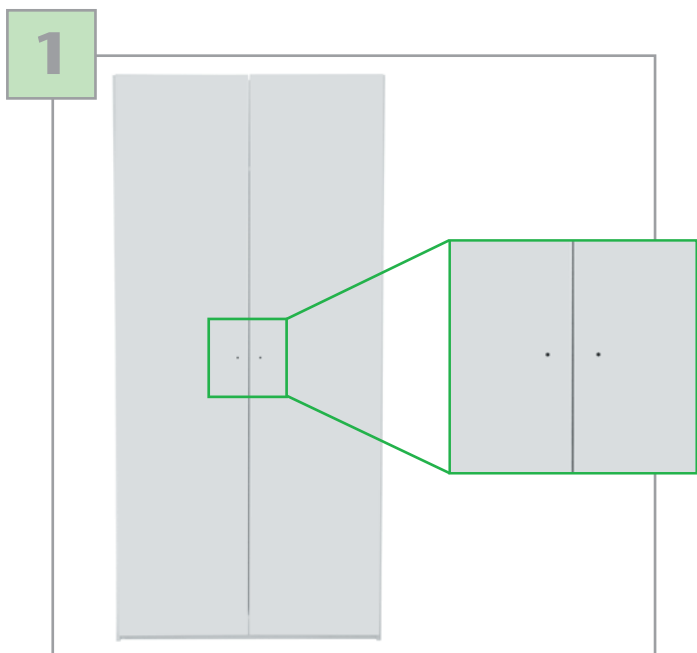
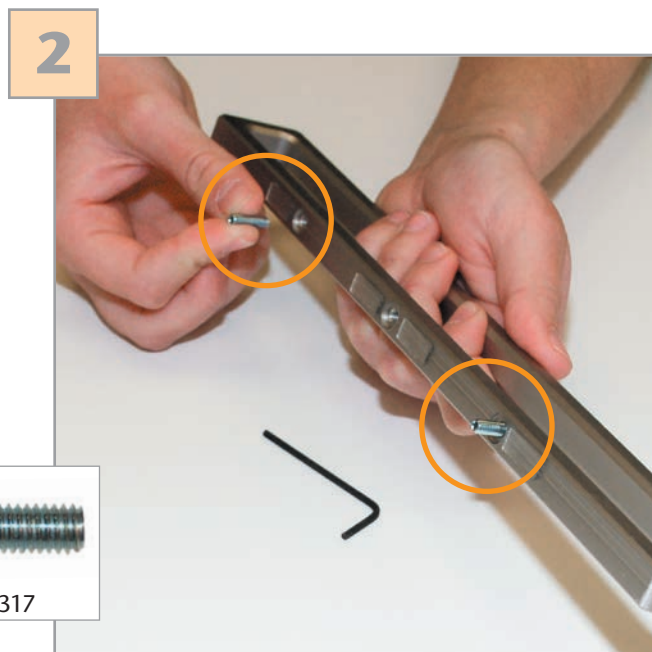
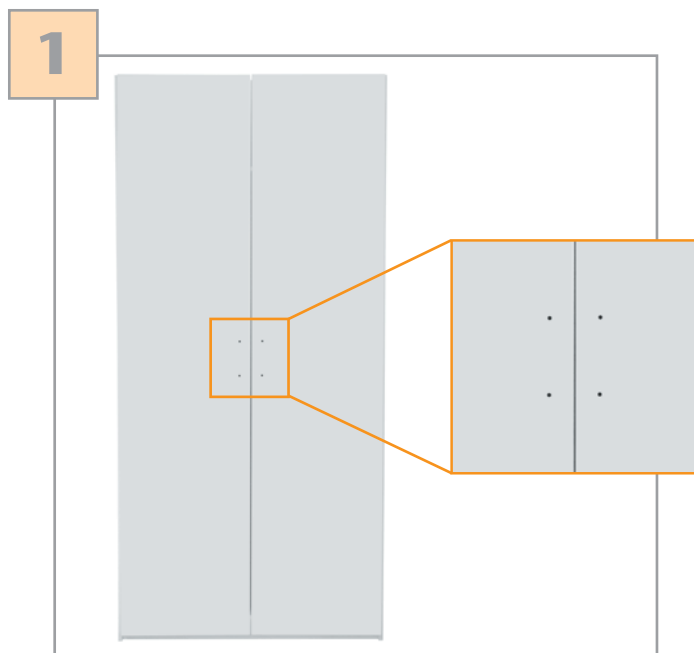

3

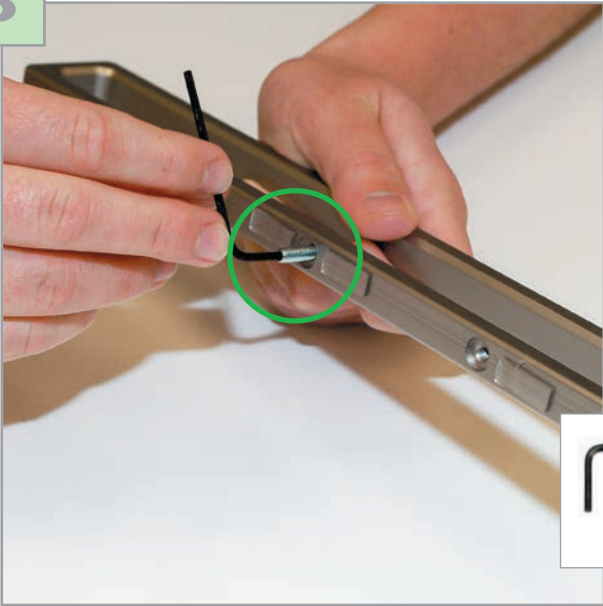

3



4

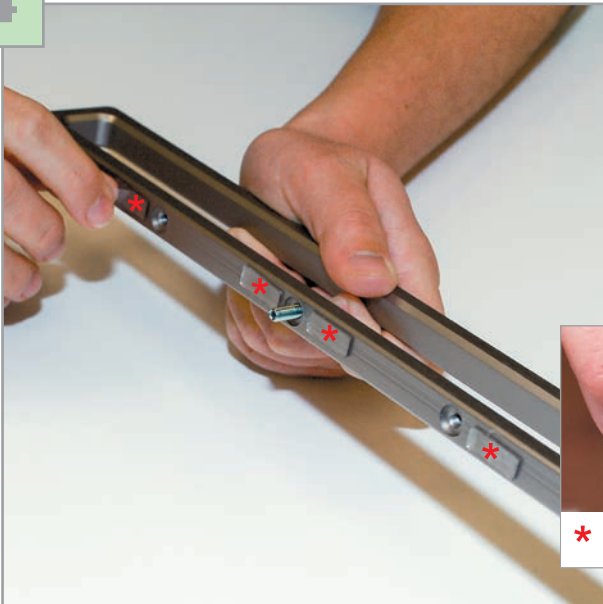

* 4x

4



5

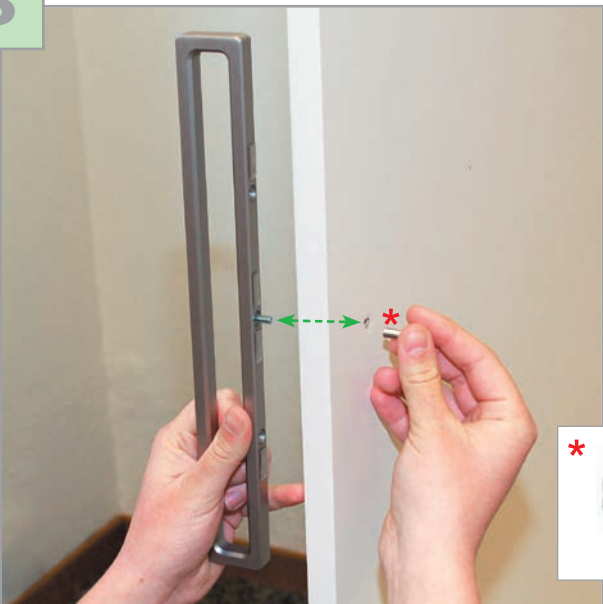

5

